

## INSTRUCTION MANUAL

# FA 550

The **CS dew point sensor FA 550** with 3-wire technology 4...20 mA and RS 485 Modbus output enables a reliable and long-term stable monitoring of the dew point in industrial applications such as in

-



## Table of Content

1	Foreword .....	3
2	Pictograms and Symbols .....	4
3	Signalwords according ISO 3864 and ANSI Z 535 .....	4
4	Intended use.....	5
5	Device description.....	6
6	Safety Instructions.....	7
7	Technical data .....	8
7.1	Signal circuits .....	9
7.1.1	Modbus.....	9
7.1.2	Current output .....	9
7.1.3	Alarm.....	9
8	Dimension .....	10
9	Electrical Wiring .....	11
9.1	Cable glands - clamping ranges.....	11
9.2	Connector pin assignment .....	11
	** The Current outputs, X5 and X6, are optional.(Active and passive version available). .....	12
9.3	Wire connection.....	13
9.3.1	General: .....	13
9.3.2	Power supply .....	13
9.3.3	Modbus RTU.....	13
9.3.4	Modbus TCP (Ethernet) Optional PoE.....	14
9.3.5	Pulse Output .....	14
10	Installation.....	15
10.1	Installing directly into the process .....	15
11	Modbus.....	17
11.1	Register Mapping measuring values .....	17
	Remark for DS400 / DS 500 / Handheld devices - Modbus Sensor Datatype:.....	17
	„Data Type R4-32“ match with „Data Type Float“ .....	17
11.2	Modbus Settings (2001...2006).....	18
11.3	Analog Scaling Settings (2007...2011) .....	18
12	Operation.....	19
12.1	Initialization .....	20
12.2	Main menu .....	20
12.3	Settings.....	21
12.3.1	Sensor Settings .....	22
12.3.2	Definition of Reference- and System pressure.....	23
12.3.3	Modbus RTU Setup.....	26
12.3.4	Modbus TCP (Optional).....	27
12.3.5	Alarm.....	30
12.3.6	User Setup .....	31
12.3.7	4 -20mA.....	32
12.3.8	FA 550 Info .....	34
13	Calibration / Adjustment .....	35
14	Warranty.....	35
15	Ordering details .....	36

## 1 Foreword

Dear Customer,

thank you for choosing the FA 550. Please read these installation and operating instructions carefully before installation and commissioning and follow our instructions. The proper functioning of the FA 550 and safe operation can only be ensured if the regulations and instructions described are strictly observed.



## 2 Pictograms and Symbols



General Warning symbol (Danger, Warning, Caution)



General note



Installation- and Instruction manual to consider (on Nameplate)



Installation- and Instruction manual to consider

## 3 Signalwords according ISO 3864 and ANSI Z 535

Danger!	Imminent danger As a consequence of incorrect handling: serious personal injury or death
Warning!	Possible hazard As a consequence of incorrect handling: possible serious injury or death
Caution!	Imminent hazard As a consequence of incorrect handling: possible personal injury or damage
Note!	Possible hazard As a consequence of incorrect handling: possible personal injury or damage
Important!	Additional notes, information, tips As a consequence of incorrect handling: Disadvantages in operation and maintenance, no danger

#### 4 Intended use

The FA 550 dew point sensor is intended for measuring the dew point or the pressure dew point in clean, dry and oil-free gases and compressed air.

It is the responsibility of the user whether the instrument is suitable for the selected application. It must be ensured that the medium is compatible with the wetted parts. The technical data listed in the data sheet are binding.

Improper handling or operation outside the technical specifications is not permitted. Claims of any kind based on improper use are excluded.

## 5 Device description

The FA 550 dew point sensor enables a reliable and long-term stable monitoring of the dew point in industrial applications.

When mounting FA 550 into compressed air systems the pressure dew point (dew point under pressure) up to 50 bar (in the special version up to 500 bar) is measured directly. When mounting FA 550 in atmospheric conditions (ambient pressure) or in the flow off sector (relaxed air) of compressed air systems the atmospheric dew point is measured.

### Typical Application

- compressed air plants (membrane- /adsorption dryers)
- Residual moisture measurement / dew point measurement in gases such as: Oxygen, nitrogen, argon, hydrogen, natural gas, biogas ...

### Advantages:

- Extremely long-term stable
- IP 67 housing grants a reliable protection in extreme industrial conditions
- Very fast response time
- Installable in the dryer by means of G 1/2" thread, optional UNF 5/8"
- Analogoutput
  - 1x 4..20mA (galv. not isolated,
- Modbus RTU Interface
- Optional
  - 2x 4..20mA galv. isolated
  - Ethernet or Ethernet PoE
  - MBus
- Calibration on location and testing with CS control and calibration set (PC connection set)

### CS Instruments Service Software

With the CS Service Software incl. USB / Modbus Adapter the Modbus settings, the scaling of the Analogue output and the assignment of the measurement values could be set.

- Analogue output 4...20 mA scalable
- Switching between °Ctd, °Ftd, % RH, °C, °F, g/m<sup>3</sup>, mg/m<sup>3</sup>, g/kg, ppm, and so on
- Calibration and adjustment
- Sensor diagnosis
- Read-out of service data

## 6 Safety Instructions



Read these operating instructions carefully before installing the FA 550. Failure to observe the instructions contained herein, in particular the safety instructions, may result in hazards to personnel, equipment and systems.

- The product may only be used in accordance with its intended purpose.
- Installation of the dew point sensor and maintenance work may only be carried out by trained personnel.
- Installation and service work must be carried out in a de-energized state.
- The applicable safety regulations must be observed!
- All work on the compressed air network must only be carried out in a depressurised state.
- Attention: Do not exceed the pressure range > 50 bar for the standard version.
- Observe the measuring ranges of the sensor!  
Overheating will destroy the sensors.
- Observe the permissible storage and transport temperature as well as the permissible operating temperature (e.g. protect the measuring instrument from direct sunlight).
- Opening the instrument, improper handling or use of force will void all warranty claims!
- **Important:** Before installation, briefly allow compressed air to flow off to remove condensate and particles, this will prevent soiling of the FA 550.
- Standing air leads to long measuring times.

## 7 Technical data

Measuring range	-80...20 °Ctd pressure dew point resp. dew point in °Ctd 0...100 % RH -20...70 °C
Accuracy:	typical  ± 1 °Ctd von 50...-20 °Ctd ± 2 °Ctd von -50...-20 °Ctd ± 3 °Ctd von -50...-80 °Ctd
Pressure range:	-1...50 bar standard
Power supply:	24V VDC (10..30 VDC)
Outputs:	4...20 mA galv. not isolated, ** <b>Optional:</b> 2x 4.20mA galv. isolated  RS 485 (Modbus RTU) ** <b>Optional:</b> Ethernet, Ethernet PoE, MBus
Protection class:	IP 67
EMV:	DIN EN 61326
Operating temperature:	-20...70 °C (ideal 0...50 °C)
Storage temperature:	-40...80 °C
Load for analogue output:	< 500 Ohm
Screw-in thread:	G 1/2" stainless steel <b>Optional:</b> UNF 5/8"
Material of housing:	Aluminium die cast
Sensor protection:	sinter filter 50 µm stainless steel
Connection:	M12, 5-pole
Display:	2" TFT Colour Display (320 x 240)
Alarm relay	max. 60V, 0,5A (AC* / DC) NC relay, relays is closed in case of alarm and power failure. Alarm value adjustable via keyboard. See Chapter Operation.

\* Peak AC

**\*\*Note:** Parallel use of both outputs (4...20mA and RS 485 Modbus) is possible.



## 7.1 Signal circuits

### 7.1.1 Modbus

- According Standard EIA/TIA-485

### 7.1.2 Current output

#### 7.1.2.1 Active

- Galvanically isolated
- 4 ... 20 mA
- $R_L < 500 \text{ Ohm}$

#### 7.1.2.2 Passive

- Galvanically isolated
- 4 ... 20 mA
- $R_L < 500 \text{ Ohm}$
- $V_{in} 12\text{-}36\text{Vdc}$

### 7.1.3 Alarm

- Galvanically isolated (dry contact)
- Max. 48Vdc, 500mA

### 8 Dimension

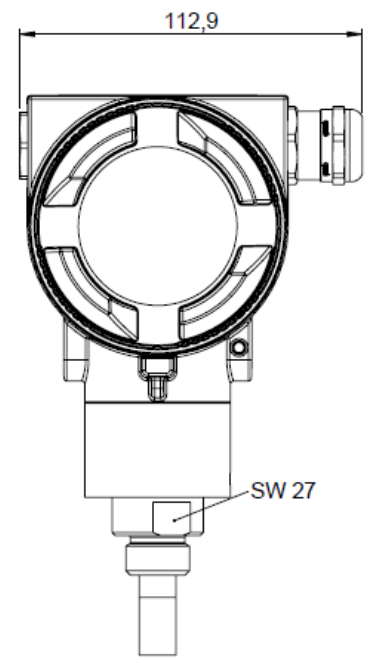
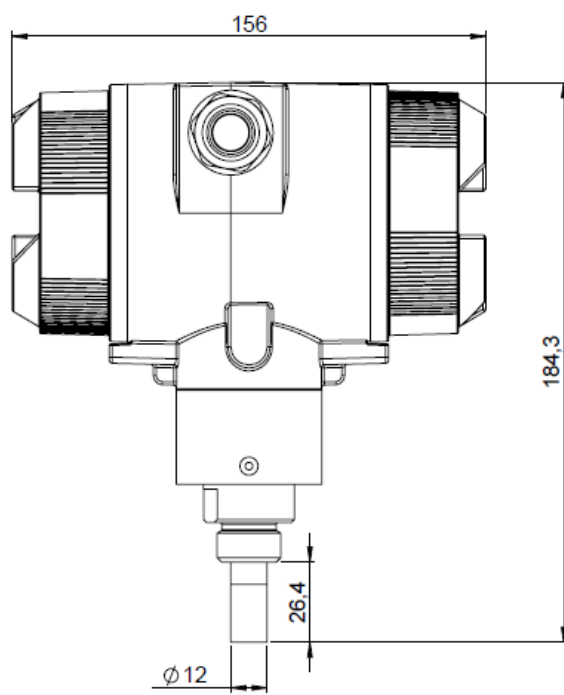

## 9 Electrical Wiring

### 9.1 Cable glands - clamping ranges

For ensuring the tightness and strain relief, connector cables with the following diameters must be used.

VA570 Standard clamping range : Ø5-9mm

VA570 Ex clamping range: Ø5-10mm

### 9.2 Connector pin assignment

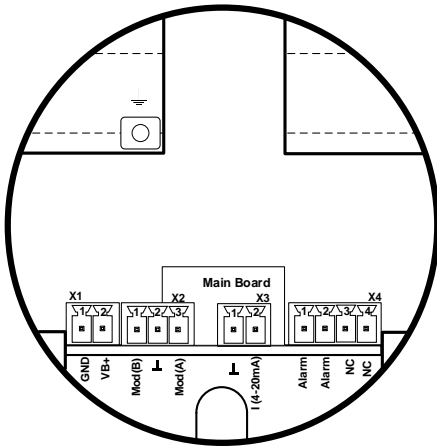

Standard version with 1x analogue output (not galvanically isolated)

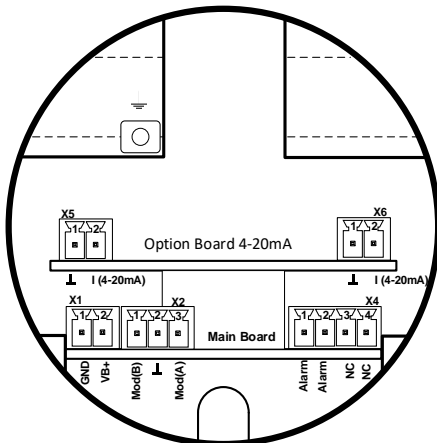

Version with option board 2x analogue outputs galvanically isolated

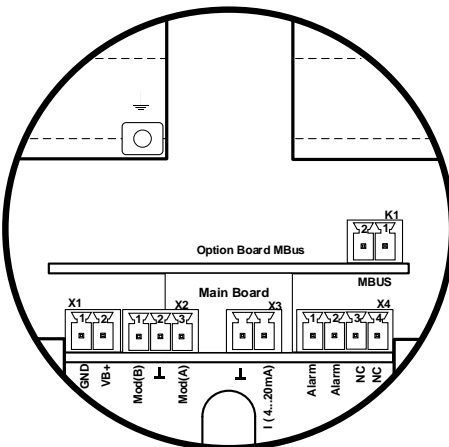

Version with option board MBUS

Connector	Pin	Signal description
<b>X1</b> Power supply	1	VB - (GND)
	2	VB+ (12V – 36 Vdc)
<b>X2</b> Modbus	1	Modbus (B)
	2	Modbus shield
	3	Modbus (A)
<b>X3</b> Current output	1	I- Active
	2	I+ Active
<b>X4</b> Direction / Pulse	1	Alarm *
	2	Alarm *
	3	Not connected
	4	Not connected
<b>X5</b> Current output 1	1	I- Active**
	2	I+ Active **
<b>X6</b> Current output 2	1	I- Active **
	2	I+ Active **
<b>K1</b> Mbus	1	Mbus
	2	Mbus

\* Outputs are galvanically isolated.

\*\* The Current outputs, X5 and X6, are optional.(Active and passive version available).

### 9.3 Wire connection

#### 9.3.1 General:

- Wiring to be done in stainless state only.
- Length of cable skinning to be minimized
- Not used cable entries must be closed with end caps
- Use of cables with cross section of  $\geq 0.25\text{mm}^2$

#### 9.3.2 Power supply

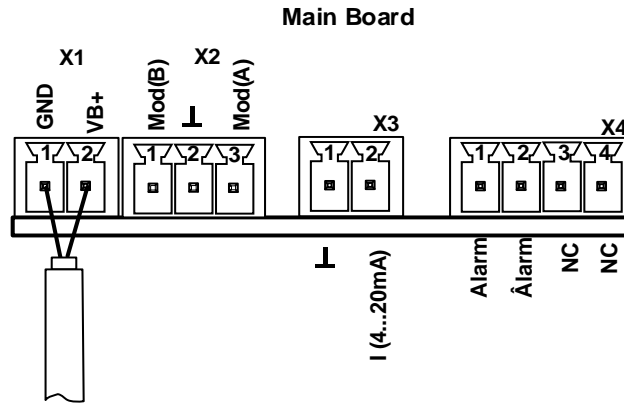

#### 9.3.3 Modbus RTU

If the sensor placed at the end of the Modbus system a termination is required.

Therefore the enclosed 120R resistor is to be connected at Pin 1 and Pin 3 of connector „X2“

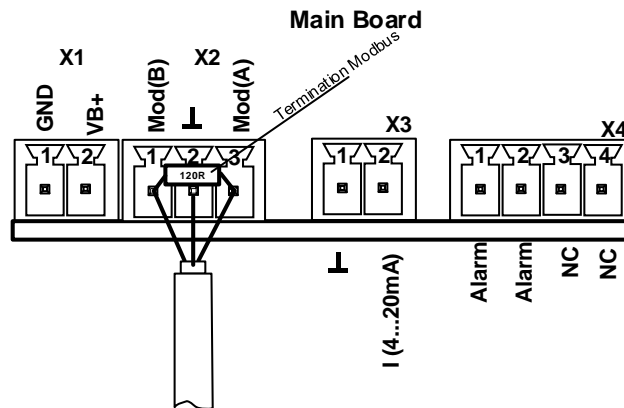

### 9.3.4 Modbus TCP (Ethernet) Optional PoE

M12 x-coded

Data LINES: 1,2 und 3,4

PoE LINES: 5,6 und 7,8

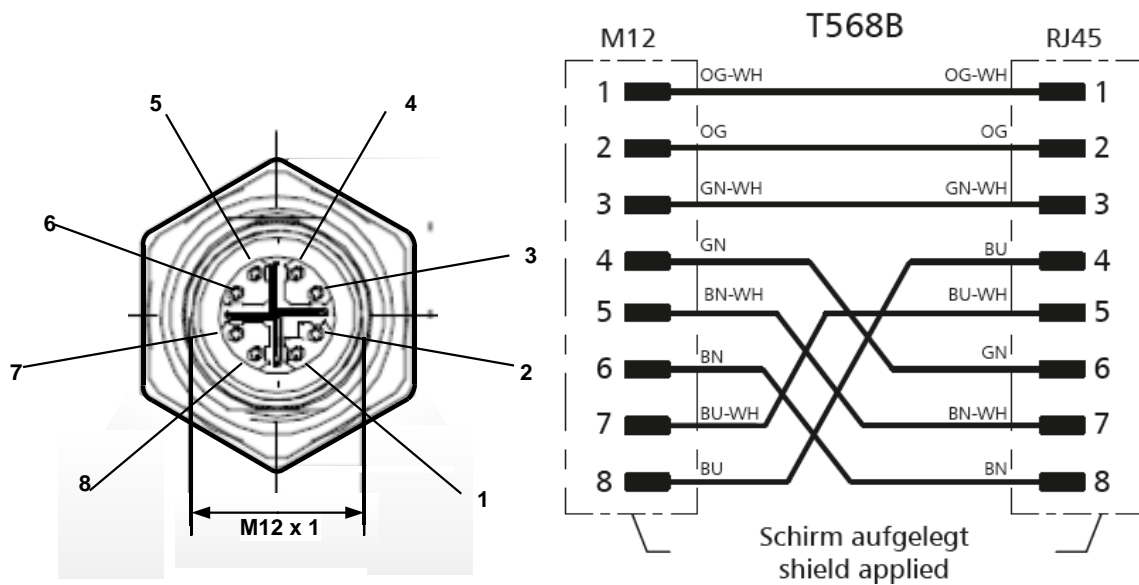

Connection cable: Cat 6.

\*PoE: Power over Ethernet

### 9.3.5 Pulse Output

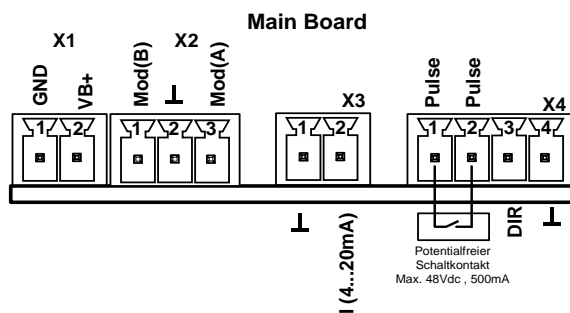

Remark: The sensor must be connected only in strain less state.

## 10 Installation

- Installation, electrical installation, commissioning, operation and maintenance of the device must only be carried by qualified personnel, which were authorized by the plant operator. The personnel must read the operating instructions and understand and follow their instructions.
- If carrying out welding work on the pipeline the grounding of the welding unit is not allowed to be done over the FA 550 itself.
- The installer has to ensure that the FA 550 is connected according to the electrical connection diagrams properly.
- The existing/ applicable national regulations governing opening and repair of the device have to be applied.
- The device fulfills the general safety requirements in accordance with EN 61010-1, the EMC requirements of IEC / EN 61326 and NAMUR recommendation NE 43.

### 10.1 Installing directly into the process

If installing directly in the process must be done in the depressurized state of the line, e.g. by using a stop valve should at both sides of the installation point.

This makes it easy to remove the transmitter for maintenance and calibration.



Insert the probe into the process and screw it as tight as possible by hand. If there is a sealing ring, check the correct centering and tighten the screw connection with a torque of 25-30 Nm..

It is not permitted to use a sealing ring with a NPT 1/2" thread. Appropriate PTFE sealing tape or sealant should be used instead..

**Please note: CS recommends the indirect installation with measuring chamber**

**Advantage:** Easy mounting and dismounting of the probe without interruption of the line. Quick response time due to quick coupling. Optimum sensor protection.

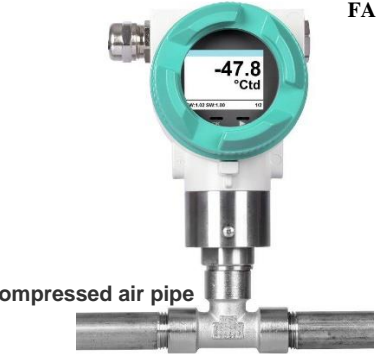
 <p>FA 500</p> <p>-47.8 °Ctd</p> <p>Measuring chamber</p> <p>Standard connection</p>	<p><b>Indirectly in the compressed air system</b></p> <p>Connect probe with measuring chamber to the compressed air pipe by means of a quick coupling. In case of compressed air containing oil and dirt particles a pre-filter should be installed in front of the measuring chamber. Compressed air flows continuously (at 7 bar approx. 1 l/min expanded) in the capillary pipe of the measuring chamber. The reaction times for the humidity reading are shorter than in case of a direct mounting.</p>
 <p>FA 550</p> <p>-47.8 °Ctd</p> <p>compressed air pipe</p>	<p><b>Directly in the compressed air system</b></p> <p>Screw in probe with G 1/2" thread pressure-tight in the center or at the top of the compressed air pipe. Take care that measurement is effected close to the compressed air flow. U-bend pipes or non-flowing compressed air, result in very slow reaction times for the moisture reading.</p>
	<p><b>Measurable gases</b></p> <p>In general, humidity can be measured in all non-corrosive gases. In case of measurements in corrosive gases please consult CS Instruments GmbH</p>



## 11 Modbus Register

The dew point sensor FA 550 comes with a Modbus RTU Interface. Before commissioning of the sensor the communication parameters

Modbus ID, Baud rate, Parity und Stop bit

must be set in order to ensure the communication with the Modbus master.

The adjustment can be done either with the CS Instruments PC service software, DS 400, DS 500 and the hand-held instrument PI 500 done.

Modbus communication default values:

- Modbus ID : 1 (1 -247)
- Baudrate: 19200 bps (1200,2400, 4800, 9600, 19200, 38400 bps)
- Parity: even (none, even, odd)
- Stoppbit: 1 (1,2)

Supported are following function codes:

- Function code 03: Read Holding Register
- Function code 16: Write multiple Register



For parameter settings/- changing see chapter 12 Operation/Modbus Settings

### 11.1 Register Mapping measuring values

Modbus Register	Modbus Address	No.of Byte	Data Type	Description	Default Setting	Read Write	Unit /Comment
1001	1000	4	Float	Temperature		R	[°C]
1003	1002	4	Float	Temperature		R	[°F]
1005	1004	4	Float	Relative Humidity		R	[%]
1007	1006	4	Float	Dew Point		R	[°Ctd]
1009	1008	4	Float	Dew Point		R	[°Ftd]
1011	1010	4	Float	Absolute Humidity		R	[g/m <sup>3</sup> ]
1013	1012	4	Float	Absolute Humidity		R	[mg/m <sup>3</sup> ]
1015	1014	4	Float	Humidity Grade		R	[g/kg]
1017	1016	4	Float	Vapor Ratio (Volume)		R	[ppm]
1019	1018	4	Float	Saturation vapor pressure		R	[hPa]
1021	1020	4	Float	Partial Vapor Pressure		R	[hPa]
1023	1022	4	Float	Atmospheric DewPoint		R	[°Ctd]
1025	1024	4	Float	Atmospheric DewPoint		R	[°Ftd]

**Remark for DS400 / DS 500 / Handheld devices - Modbus Sensor Datatype:**

„Data Type R4-32“ match with „Data Type Float“

### 11.2 Modbus Settings (2001...2006)

Modbus Register	Modbus Address	No.of Byte	Data Type	Description	Default Setting	Read Write	Unit /Comment
2001	2000	2	UInt16	Modbus ID	1	R/W	Modbus ID 1...247
2002	2001	2	UInt16	Baudrate	4	R/W	0 = 1200 1 = 2400 2 = 4800 3 = 9600 4 = 19200 5 = 38400
2003	2002	2	UInt16	Parity	1	R/W	0 = none 1 = even 2 = odd
2004	2003	2	UInt16	Number of Stopbits		R/W	0 = 1 Stop Bit 1 = 2 Stop Bit
2005	2004	2	UInt16	Word Order	0xABCD	R/W	0xABCD = Big Endian 0xCDAB = Middle Endian
2006	2005	2	UInt16	Modbus Enabled	FA500: 1 FA510: 1 FA515: 0	R/W	0 = Modbus disabled 1 = Modbus Enabled

### 11.3 Analog Scaling Settings (2007...2011)

Modbus Register	Modbus Address	No.of Byte	Data Type	Description	Default Setting	Read Write	Unit /Comment
2007	2006	4	UInt32	Output Value	4	R/W	0 = 4-20mA disabled 1 = Temperature [°C] 2 = Temperature [°F] 3 = relative Humidity [%] 4 = DewPoint [°C] 5 = DewPoint [°F] 6 = Absolute Humidity [g/m3] 7 = Absolute Humidity [mg/m3] 8 = Humidity Grade [g/kg] 9 = Vapor Ratio [ppm] 10 = Saturation VaporPressure[hPa] 11 = Partial Vapor Pressure [hPa] 12 = Atmospheric DewPoint [°C] 13 = Atmospheric DewPoint [°F]
2009	2008	4	float	4mA Scale Low	-80	R/W	
2011	2010	4	float	20mA Scale High	20	R/W	

Modbus installation, Modbus settings and further information refer to the manual CS Instruments "**Modbus Installation and Operating Instructions FA 5xx sensors**"

## 12 Operation

Die Bedienung des FA 550 erfolgt mittels 2 optischen Tasten, deren Bedienung direkt über / durch die Glasabdeckung erfolgt. Somit kann der FA 550 ohne öffnen des Deckels von außen bedient werden.

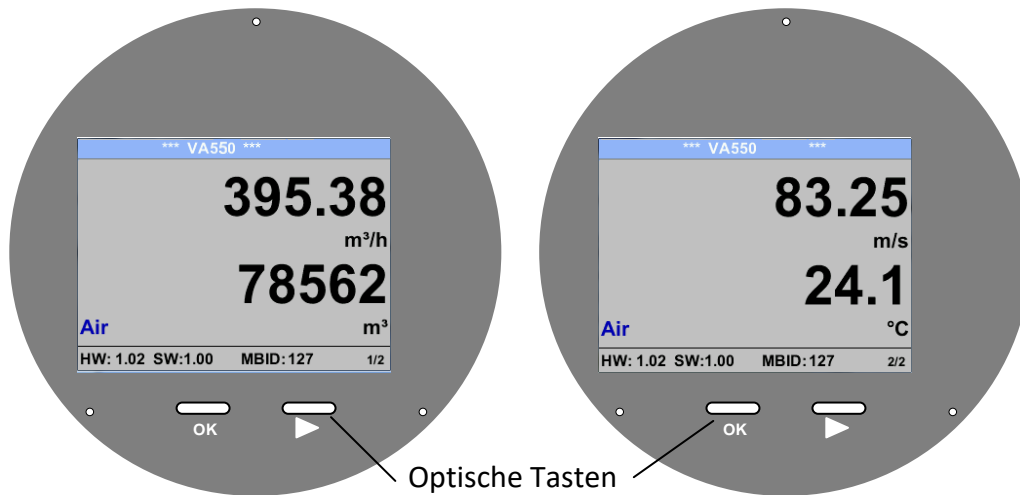

Die Auswahl der einzelnen Menüpunkte erfolgt durch die Taste „>“ und Bestätigung durch Taste „OK“

Bei allen weiß hinterlegten Feldern können Angaben oder Änderungen gemacht werden, Auswahl zur Eingabe wird durch gelbe Hintergrundfarbe angezeigt.

Wörter in *grüner Schrift* verweisen hauptsächlich auf die Abbildung(en) in dem Kapitelabschnitt. Aber auch wichtige Menüpfade oder Menüpunkte, die damit im Zusammenhang stehen sind in *grüner Schrift gekennzeichnet*.

Die Menüführung ist generell in *grüner Schrift*!

Das Inhaltsverzeichnis sowie die Kapitelverweise in *blauer Schrift* enthalten Links zu den jeweiligen Kapitelüberschriften.

## 12.1 Initialization



After switching on the FA 550, the initialized screen is displayed followed by the main menu.

## 12.2 Main menu

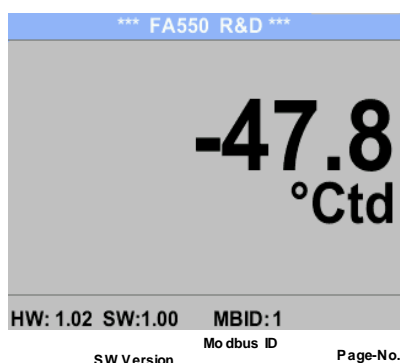

### Page 1

Display value is the pressure dew point, here in °Ctd. (When measured under pressure)  
The pressure dew point is always based on the pressure in the compressed air pipe.

Switching to pages 2-3 or back by pressing key „ $\Delta$ “

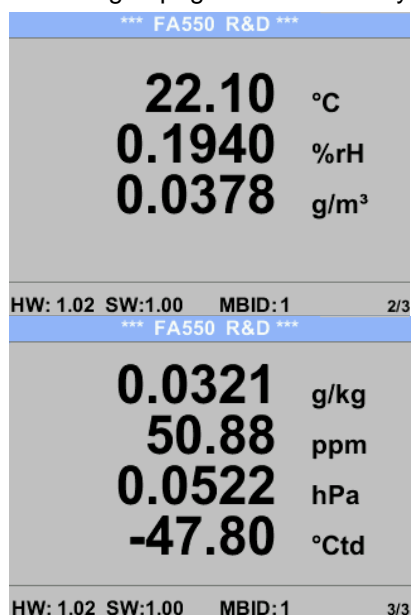

### Page 2

Value 1: Temperature in °C  
Value 2: relative humidity in %  
Value 3: vapour humidity in g/m<sup>3</sup>

### Page 3

Value 1: Absolute humidity in g/kg \*\*  
Value 2 Parts per Million \*\*  
Value 3: Atmospheric dew point (when the reference pressure is set to atmospheric pressure 1013,25 hPa) or reference dew point based on the reference pressure setting.  
\*\* For the calculation, the input of the system pressure is mandatory. For entering see chapter. see 8.3.2.

### 12.3 Settings

The settings menu could accessed by pressing the key „OK“.

Nevertheless, the access to the *settings menu* is password protected.



Factory settings for password at the time of delivery: 0000 (4 times zero).

If required the password could be changed at *Setup–User setup–Password*.

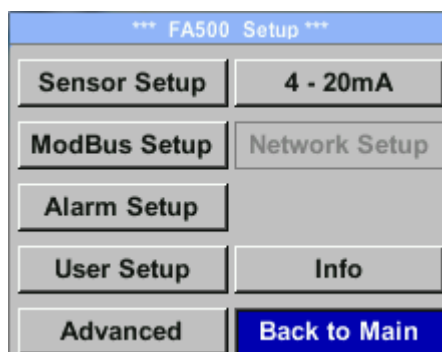

Selection of a menu item or to change a value is done with the key „ $\Delta$ “, a final move to the chosen menu item or takeover of the value change needs the confirmation by pressing the key „OK“

### 12.3.1 Sensor Settings

*Settings → Sensor Setup*



For changes, first select the menu item with key „ $\Delta$ “ **and** then confirm it with “OK”.

#### 12.3.1.1 Definition of units for Temperature, pressure and abs. humidity

*Settings → Sensor Setup → Units*

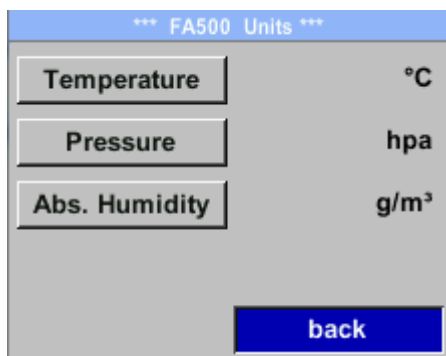

To make changes to the unit for the respective measurement value, first select by pressing „ $\Delta$ “ the field of the „measurement value“ and activate „it with „OK”.

Selection of the new unit with „ $\Delta$ “

In case the quantity of units selectable are not presentable on one page, please move to next page by pressing „ $\ll$ “.

Confirm selection by pressing 2x „OK”.

Procedure for all 3 measurements variables is analogous.

Leaving the menu with „back”

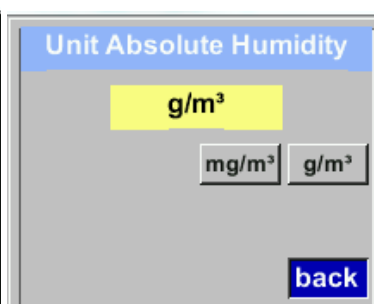
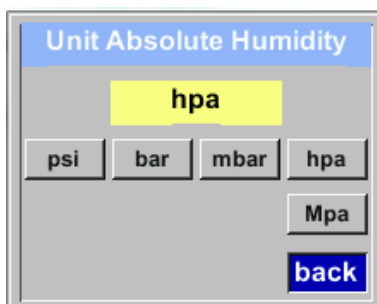
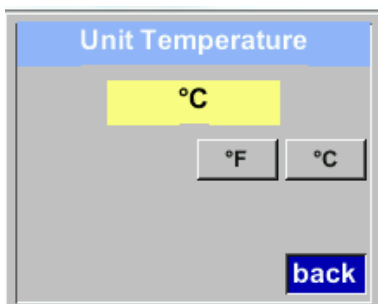



Settings → Sensor Setup → Pressure

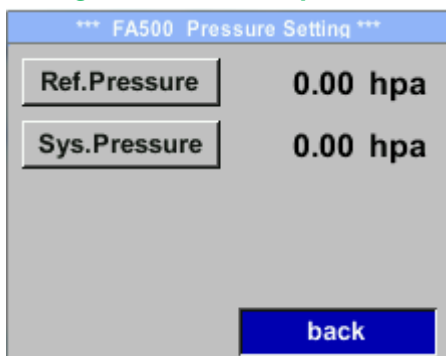

To make changes, first select a menu with button „ $\Delta$ “ and confirm selection by pressing „OK“.

Settings → Sensor Setup → Pressure → Ref. Pressure



In order to change, e.g. the unit, first select by pressing key „ $\Delta$ “ the field “Units” and then key “OK”.

Select with the key „ $\Delta$ “ the correct unit and then confirm selection by pressing 2x „OK”.

Input / change of the value by selecting the respective position with button „ $\Delta$ “ and entering by pressing button „OK” .

By pressing „ $\Delta$ “ the position value is incremented by 1. Complete input/change with "OK" and activate next number position.

Inputs / changes to be confirmed with button „OK”.

Procedure for entering / changing the system pressure is analogous.

Settings → Sensor Setup → Pressure → Sys. Pressure

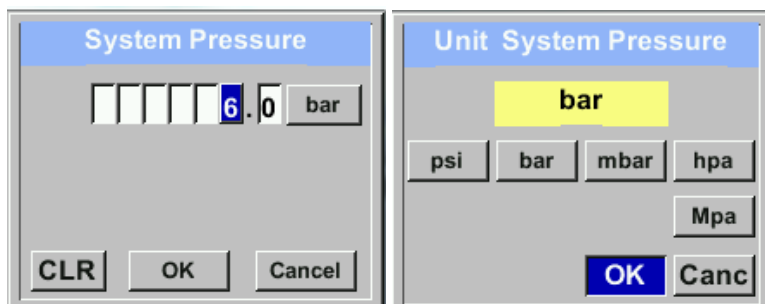



12.3.2.1 Calibration

Settings → Sensor Setup → Calibration

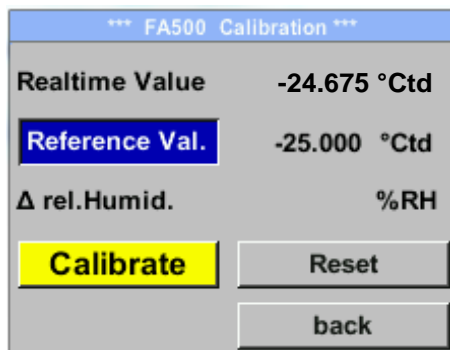
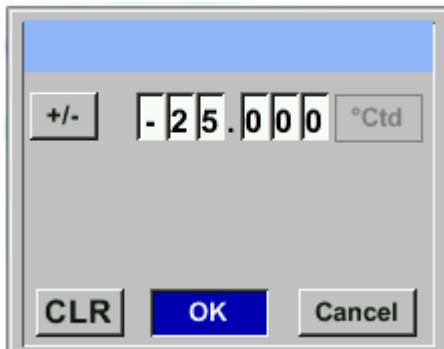
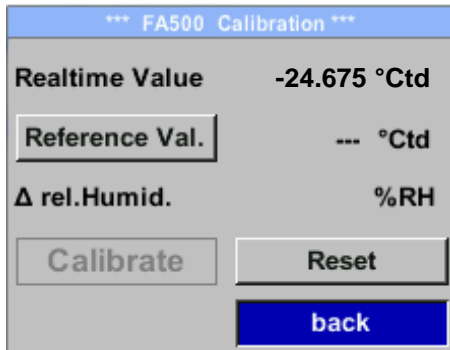

Here, a one-point calibration can be performed

For the Calibration select with button „ $\Delta$ “ the menu „*Reference Val.*“ and open the input menu with „*OK*“.

Input / change of the value by selecting the respective position with button „ $\Delta$ “ and entering by pressing button „*OK*“ .

By pressing the button „*Calibrate*“ the new reference value will be taken over.

A calibration could be set back to „out of factory“ settings with button „*Reset*“.

Leaving the menu with „*back*“

### 12.3.3 Modbus RTU Setup

The dew point sensor FA 550 comes with a Modbus RTU Interface.  
Before commissioning the sensor the communication parameters

- Modbus ID, Baud rate, Parity und Stop bit

must be set in order to ensure the communication with the Modbus master.

#### Setup → Sensor Setup → Modbus Setup

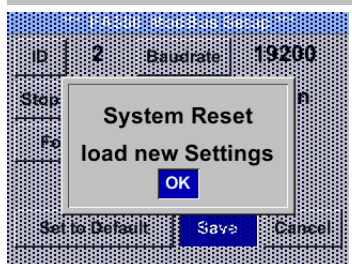
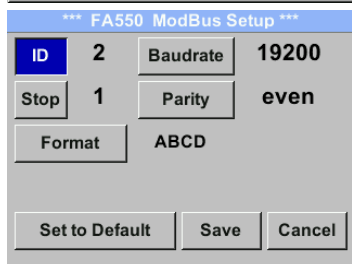
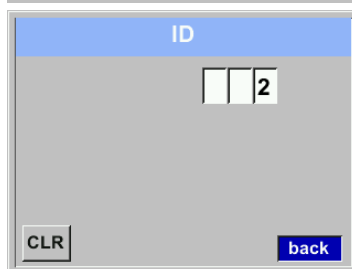
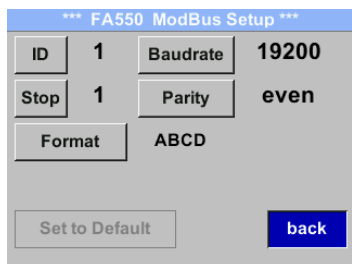

For changes, e.g. the sensor ID, first select by pressing key „ $\Delta$ “ the field “**ID**” and then key “**OK**”.

Select the desired position by pressing the “**>**” and select with “**OK**” button.

Change values by pressing the „ $\Delta$ “ values takeover by pressing “**OK**”.

Inputs for remaining information is analogous.

With “**Format**”, the word order of transmission could be changed between ABCD (Little Endian) and CDBA (Middle Endian).

Saving the changes by pressing “**Save**”, therefore select it first with key „ $\Delta$ “ and afterwards confirm it with “**OK**”.

For the new settings the sensor needs a “**Reset**” (Restart) which needs to be confirmed with „**OK**“

With the button “**Default**” the settings are set back to “Out of factory” values

**Default values out of factory:** Modbus ID: 1  
Baud rate: 19200  
Stop bit: 1  
Parity: even

**Remark:** If the sensor placed at the end of the Modbus system, a termination is required.  
Therefore, the enclosed 120R resistor is to be connected at Pin 1 and Pin 3 of connector „X2“ correctly..

### 12.3.4 Modbus TCP (Optional)

#### 12.3.4.1 Setup

The dew point sensor FA 550 comes **optional** with a Modbus TCP Interface (HW Interface:M12 x 1 X-coded connector).

Device supports with this option the Modbus TCP protocol for communication with SCADA systems. TCP port is set to 502 by default. Port can be changed at the sensor or using PC Service Software

Modbus device address (Unit Identifier) can be set in the range of 1- 255.

Specification and description of the Modbus protocol is free to download on: [www.modbus.org](http://www.modbus.org).

Supported Modbus commands (functions):

Command	Code	Description
Function Code	3	(Read holding register)
Function code	16	(Write multiple registers)

For more details, please see **VA 5xx Modbus RTU\_TCP Installation V1.05**

**Settings → Network Setup**

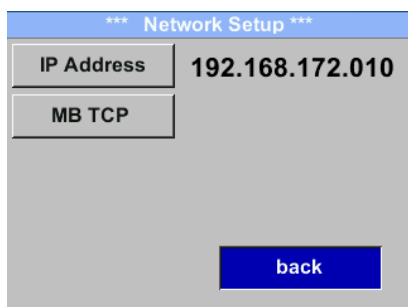

#### 12.3.4.1.1 Network Setup DHCP

**Settings → Network Setup Settings → IP Address**

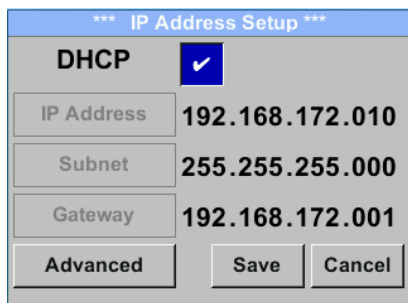

Here you can set up and made a connection, with or without *DHCP*, to a computer.

**Remark:**  
With activated *DHCP* the automatic integration of the sensor in an existing network is possible, without a manual configuration.

Storing of settings by pressing *“Save”*

12.3.4.1.2 Network Settings static IP

Settings → Network Setup Settings → IP Address → IP Address

Settings → Network Setup Settings → IP Address → Sub Netz

Settings → Network Setup Settings → IP Address → Gateway

For manual (static) IP, the *"IP Address"*, *"Subnet"* and *"Gateway"* selection keys must be selected and activated with *"OK"*.

The first data field of the selection, in this case the IP address, is then marked (red).

Confirm with *"OK"* the corresponding input menu is opened.

By means of *">"*, the next data field is changed.

Select the desired position with the *">"* key and activate it with the *"OK"* key.

Change the values with the *">"* key, and accept the values with the *"OK"* key.

Procedure for *"Subnet"* and *"Gateway"* is analogous.

Store the settings by *„Save“*

### 12.3.4.1.3 Modbus TCP Settings

Settings → Network Setup Settings → IP Address → MB TCP

*** MB TCP ***	
ID	5
Port	502
Byte Order	ABCD
<div style="display: flex; justify-content: space-between;"> <span>Set to Default</span> <span>back</span> </div>	

Settings → Network Setup Settings → IP Address → ID

Settings → Network Setup Settings → IP Address → Port

Modbus TCP UI

CLR
back

Modbus TCP Port

CLR
zurück

For changes, e.g. the sensor ID, first select by pressing key „>“ the field **“ID”** and then key **“OK”**.

Select the desired position by pressing the **“>”** and select with **“OK”** button.

Change values by pressing the **„>“** values takeover by pressing **“OK”**.

Input for the port is done analogue.

By means of the button **“Byte Format”** it is possible to change the data format (Word Order). Possible formats are **“ABCD”** (Little Endian) and **“CDAB”** (Middle Endian)

Saving the changes by pressing **“Save”**, therefore select it with key **„>“** and then confirm it with **“OK”**.

Reset to the default settings by activating **“Set to Default”**-

### 12.3.5 Alarm

#### Settings → Alarm Setup

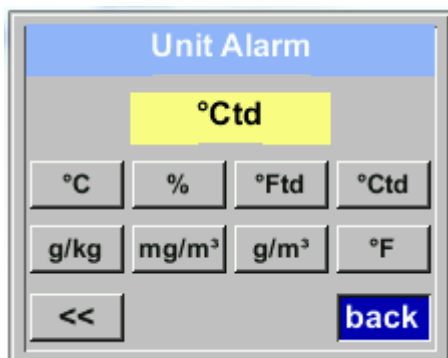
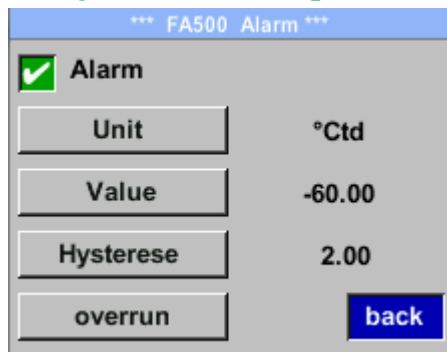

The Alarm could be activated / deactivated with the option button „Alarm“, selecting it with „ $\Delta$ “ and change it with button „**OK**“



The alarm could be set to one of the values (units), see picture „*Unit Alarm*“.

„*Value*“ defines the alarm value, here  $-60^{\circ}\text{Ctd}$ .

„*Hysterese*“ defines the hysteresis value

With button „*overrun*“ or „*underrun*“ the way how the alarm is triggered

Overrun: Value is exceeding the „*Value*“

Underrun: Value is going below „*Value*“

### 12.3.6 User Setup.

*Settings* → *User Setup*

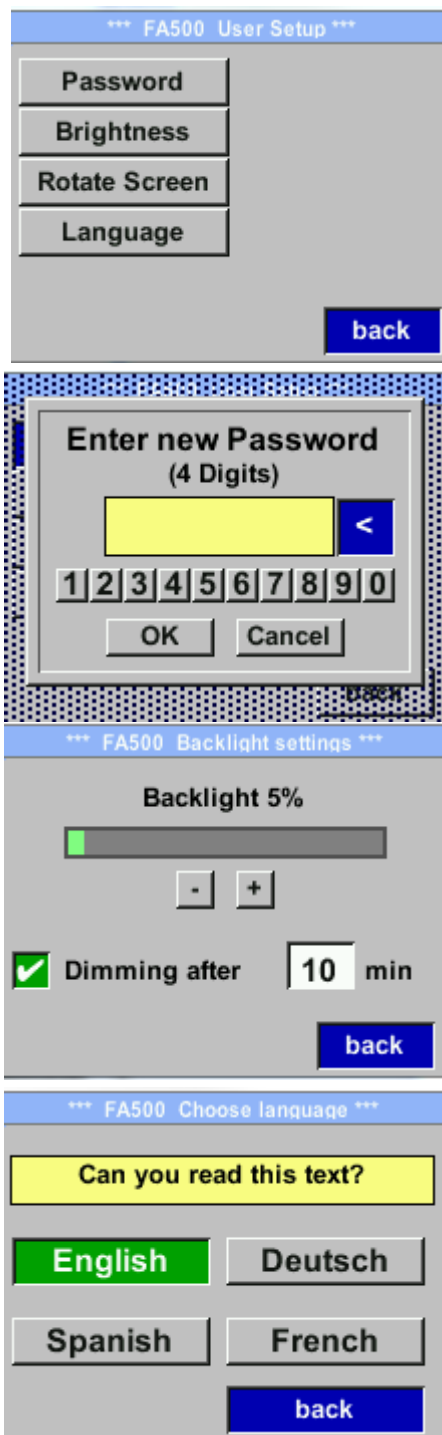

To make changes, first select a menu with button „ $\Delta$ “ and confirm selection by pressing „*OK*“ .

It is possible to define a password. The required password length is 4 digits. Please select with button „ $\Delta$ “ a figure and confirm it with „*OK*“ .Repeat these 4 times.

With „ $\leftarrow$ “ the last figure could be deleted.

Password input have to be inserted twice.

Confirmation of input/password by pressing „*OK*“.

With button „*Brightness*“ could the display brightness adapted/changed. Therefore move with „ $\Delta$ “ either to the “+” or “-“ button and change the brightness with „*OK*“.

With „*Dimming after*“ a display dimming could be activated. The dimming starts after the time period defined in time field. Trigger is last keypress .

„*Rotate Screen*“ will rotate the display content by 180°.

Currently there are 4 languages integrated which could be selected by means of button „ $\Delta$ “.

Language activation with activation of button „*back*“ and confirming with „*OK*“

### 12.3.7 4 -20mA

Settings → 4-20mA

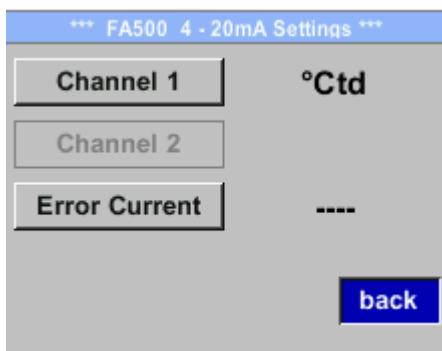

To make changes, first select a menu with button „ $\Delta$ “ and confirm selection by pressing „OK“.

Settings → 4-20mA → Channel 1 → Status

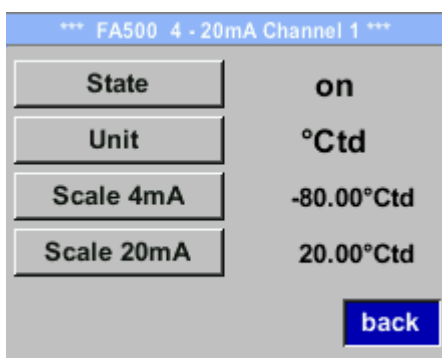

The 4-20 mA Analogue output of the Sensor FA 500 can be individually adjusted.

Activation „on“ or deactivation „off“ of the alarm by selecting button „State“ and confirming with „OK“.

Settings → 4-20mA → Channel 1 Unit

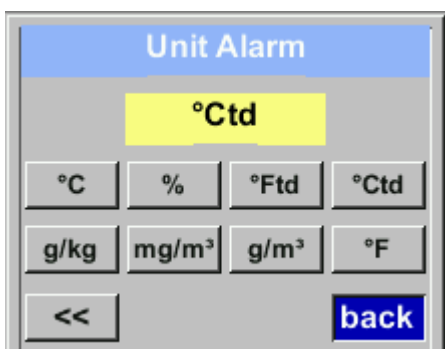

To select a measurement value, a corresponding / appropriate unit needs to be defined. Select „Unit“ with „ $\Delta$ “ and open the menu with „OK“. Select required unit with „ $\Delta$ “ and takeover it by pressing „OK“.



Settings → 4-20mA → Channel 1 → Scale 4mA

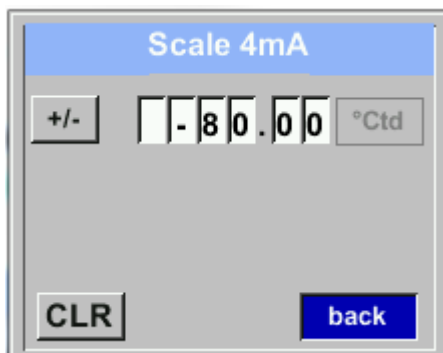

„Scale 4mA“ and „Scale 20mA“ allows defining the desired scaling.

With button „ $\Delta$ “ select the menu „Scale 4mA“ or „Scale 20mA“ and open it with „OK“

Settings → 4-20mA → Channel 1 Scale 20mA

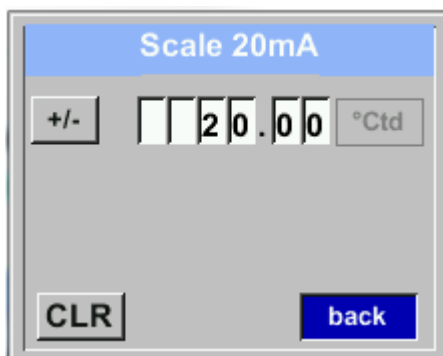

Input is analogous to that described above, using the „CLR“ the complete entry will be deleted.

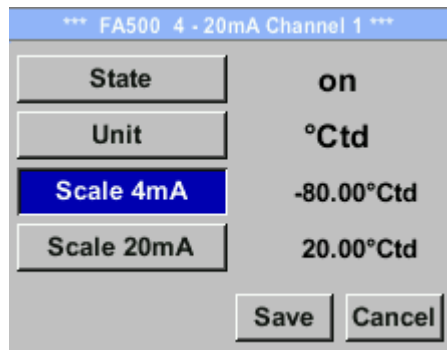

Takeover the inputs/changes with „Save“, or discard the changes with „Cancel“.

Leaving menu with „back“

Settings → 4-20mA → Channel 1 → Error Current

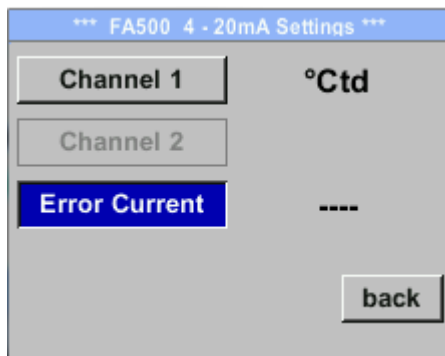

This determines what is output in case of an error at the analog output.

- 2 mA Sensor error / System error
- 22 mA Sensor error / System error
- None Output according Namur (3.8mA – 20.5 mA)
  - < 4mA to 3.8 mA Measuring range under range
  - >20mA to 20.5 mA Measuring range exceeding

To make changes first select a menu item "Current Error" with button „ $\Delta$ “ and then select by pressing the „OK“ the desired mode

With „back“ change to the settings menu.

12.3.8 FA 550 Info

Settings → Info

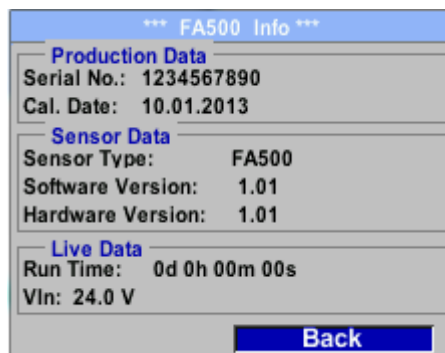

Here you get a brief description of the sensor data incl. some production data

## 13 Calibration / Adjustment

### **From the manufacturer**

According to DIN ISO certification of the measuring instruments we recommend regular calibration and, if necessary, adjustment of the instrument by the manufacturer. The calibration cycles should fit your internal scheme. In the course of the DIN ISO certification, we recommend for FA 550 a calibration cycle of one year. If requested we can carry out the calibration on your premises.

## 14 Warranty

If you have reason for complaint, we will of course repair any faults free of charge if it can be proven that they are manufacturing faults. The fault should be reported immediately after it has been found and within the warranty time guaranteed by us. Excluded from this warranty is damage caused by improper use and non-adherence to the instruction manual.

The warranty is also cancelled once the measuring instrument has been opened provided this is not described in the instruction manual for maintenance purposes. This is also the case if the serial number has been changed, damaged or removed.

The warranty time for FA 550 is 12 months for the instrument and 6 months for accessories if no other terms have been agreed. Warranty services do not extend the warranty time.

If in addition to the warranty service necessary repairs, adjustments or similar are carried out, the warranty services are free of charge but there is a charge for other services such as transport and packing costs. Other claims, especially those for damage occurring outside the instrument are not included unless responsibility is legally binding.

### **After-sales service after the warranty time has elapsed**

We are, of course, there for you after the warranty time has elapsed. In the case of function faults, please send us your measuring instrument with a brief description of the defect. Please also indicate your telephone number so that we can contact you if necessary.

## 15 Ordering details

<i>Bestell Nr.</i>	<i>Beschreibung</i>
0699.0501	FA 550 dew point sensor Option: A1-- -80..+20 °Ctd A2 ---20..+50 °Ctd A3 ---40..+30 °Ctd A4 ---60..+30 °Ctd
0553.0104	Connection cable, length: 5 m
0553.0105	Connection cable, length:10 m
0699.3390	Standard measuring chamber for compressed air up to 16 bar
0699.3290	Bypass-Measuring chamber Stainless steel (1.4305)
0699.3590	High-pressure measuring chamber up to 350 bar *
0699.3396	Precision calibration at -40 °Ctd or 3° Ctd incl. ISO certificate
0554.2007	CS Service Software for FA/VA sensors incl. PC connection set, USB connection and interface adapter to the sensor



# KONFORMITÄTSERKLÄRUNG

DECLARATION OF CONFORMITY

Wir  
We CS Instruments GmbH  
Am Oker 28c, 24955 Harrislee

Erklären in alleiniger Verantwortung, dass das Produkt  
Declare under our sole responsibility that the product

Feuchtesensoren FA 500  
Dew point sensors FA 500

den Anforderungen folgender Richtlinien entsprechen:  
We hereby declare that above mentioned components comply with requirements of the following EU directives:

Elektromagnetische Verträglichkeit Electromagnetic compatibility	2014/30/EU 2014/30/EC
---	--------------------------

Angewandte harmonisierte Normen:

Harmonised standards applied:

EMV-Anforderungen EMC requirements	EN 61326-1: 2006-10 2013-07 EN 61000-3-2 : 2015-3
---------------------------------------	--

Anbringungsjahr der CE Kennzeichnung: 16  
Year of first marking with CE Label: 16

Das Produkt ist mit dem abgebildeten Zeichen gekennzeichnet.  
The product is labeled with the indicated mark.



Harrislee, den 21.06.2016



Wolfgang Blessing Geschäftsführer